

Installation Instructions

Eibach Inc .264 Mariah Circle Corona, CA 92879 USA Tech Support 800-507-2338 ext. 114



PRO-TRUCK COILOVER 2.0 #E86-82-099-01-20

TOYOTA SEQUOIA (XK80)

Kit Contents

Description	Part Number	Quantity
Coil over Assembly 2.0	82132.9003	2
Height Adjustment Tool	ETCO 2.0	1

Tool List

10mm socket or wrench	32mm axle socket	Pull straps
12mm socket or wrench	Dike cutters	Zip ties
14mm socket or wrench	2 hammer	3/8" torque wrench
19mm socket or wrench	2 new cotter pins	1/2" torque wrench
24mm socket or wrench	Pry bar	

Notes

Read all instructions before beginning installation

Only qualified mechanics experienced in the installation and removal of suspension components should perform this installation.

Use of a hoist and screw jack is highly recommended and will substantially reduce installation time.

Never work on or under a vehicle unless it is properly supported.

Installation



Step 1

Step 1. Remove the 10mm bolt holding the wheel speed sensor to the upper control arm.



Step 2

Step 2. Remove the 10mm bolt for the wheel speed sensor to the lower brake line bracket.

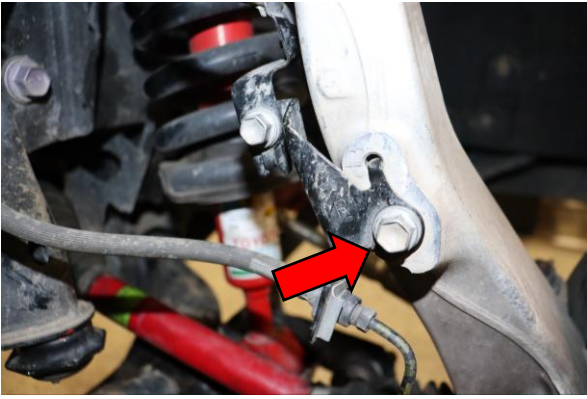

Step 3

Step 3. Remove the 12mm bolt for the brake line bracket. (Being careful NOT to bend the hard line pull the bracket away from the knuckle gently as this gives extra play so we do not risk stretching the brake line).

Step 4. Remove the 19mm nut and 19mm bolt attaching the end link to the knuckle (do this on both sides at this time).

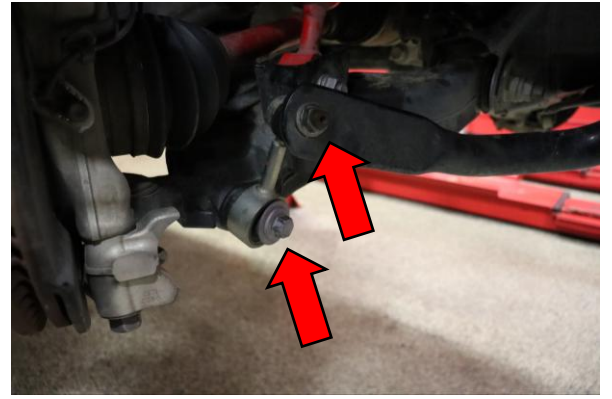

Step 4



Step 5

Step 5. IF equipped with a skid plate remove.

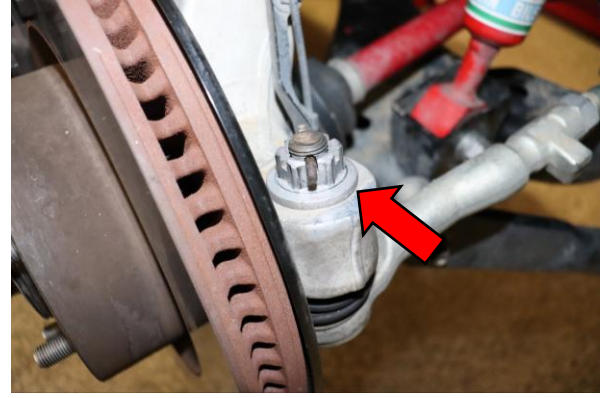

Step 6

Step 6. Remove the cotter pin, then, loosen and remove the 24mm nut that secures the tie rod to the knuckle.



Step 7

Step 7. Using two hammers, strike the knuckle to release the tie rod taper.

Step 8. Remove the axle dust cover.



Step 8



Step 9

Step 9. Remove the axle cotter pin and cotter pin nut.



Step 10

Step 10. Remove the 32mm Axle nut and separate axle spindle from the wheel bearing.



Step 11

Step 11. Secure the knuckle with a strap to keep the control arm from falling.



Step 11b

Step 11b. Remove the OE cotter pin, then, loosen but do not remove the 19mm nut.



Step 12

Step 12. Using two hammers, strike the knuckle to release the taper on the upper ball joint.



Step 12b

Step 12b. Position Pry Bar in-between the spring coils to press down on the upper control arm.



Step 12c

Step 12c. Apply pressure on the upper control arm and remove the nut. Then release the pressure on the pry bar while holding the knuckle so it doesn't fall.

Step 12d. Remove the 22mm nut and bolt from the lower control arm.



Step 12d

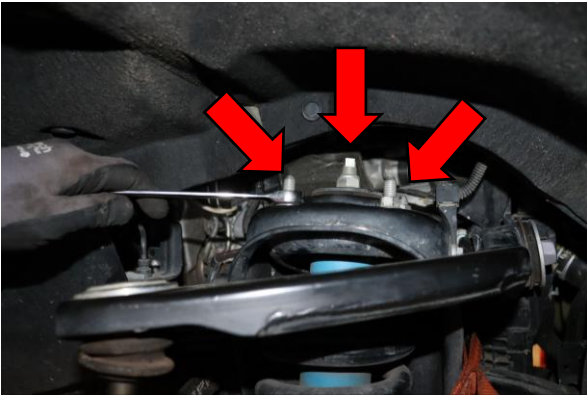

Step 13

Step 13. Remove the 3x 14mm nuts holding the shock to the chassis.

Step 14. Remove the old strut assembly.



Step 14



Step 15

Step 15. Install the new coil over. Out of box height is set to be level with OE rear spring.

Step 16. Install (hand tight as this will make it easier to install the lower shock bolt) the 3x flange nuts provided.



Step 16

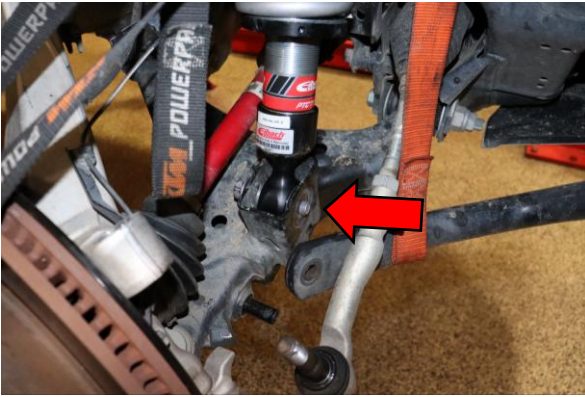

Step 17

Step 17. Install the 22mm lower shock bolt with 2 spacer washers.

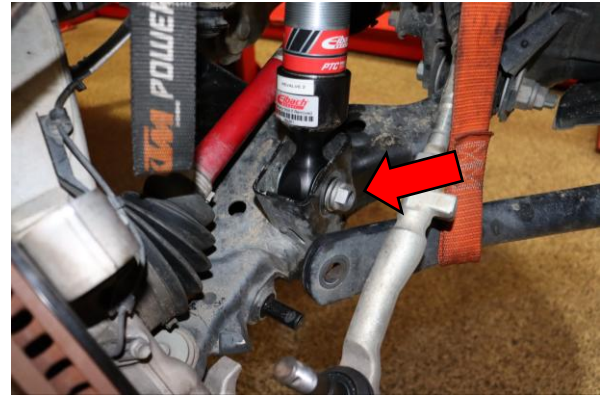

Step 18

Step 18. Torque the nut to (122 ft-lb).



Step 19

Step 19. Torque the nut the upper mount to (33 ft-lb).



Step 20

Step 20. Pry down on the upper control arm, line up the upper ball joint with the knuckle, and thread on the 19mm nut.



Step 20b

Step 20b. Torque to 92 ft-lb (if the holes don't line up for the clip tighten it a little more) and re install the cotter clip.

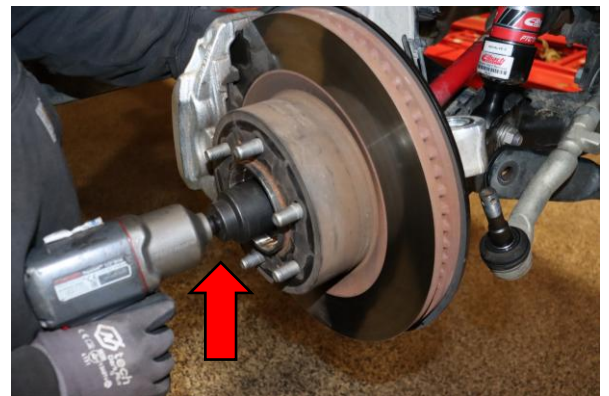

Step 21

Step 21. Reinstall 32mm axle nut and torque to (251 ft-lbs).



Step 22

Step 22. Reinstall axle cotter pin nut and cotter pin.



Step 23

Step 23. Reinstall axle dust cover.



Step 24

Step 24. Once both shocks have been replaced, Re-install the sway bar link into the knuckle on both sides, a pry bar may be needed to align the end link.

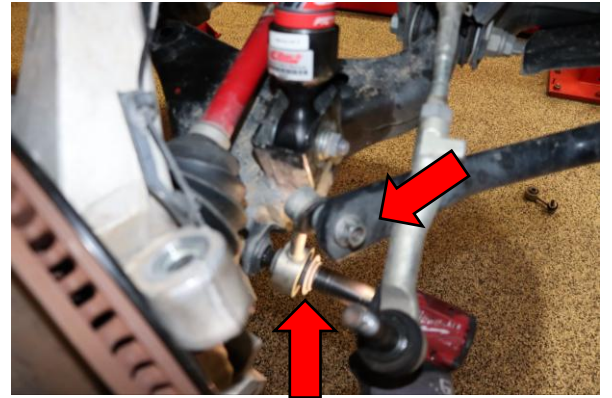

Step 25

Step 25. Torque the 19mm nut and bolt to (111 ft-lb) on both sides.



Step 26

Step 26. Re-install the tie rod into the knuckle and torque the 24mm nut to (89 ft-lb), then, re-install the OE cotter pin.



Step 27

Step 27. Re-install the 12mm bolt for the brake line bracket.

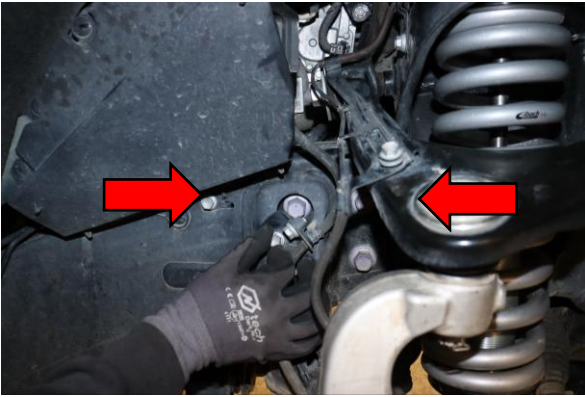

Step 28

Step 28. Re-install the 10mm bolt for the wheel speed sensor to the lower brake line bracket



Step 29

Step 29. Re-install the 10mm bolt holding the wheel speed sensor to the upper control arm

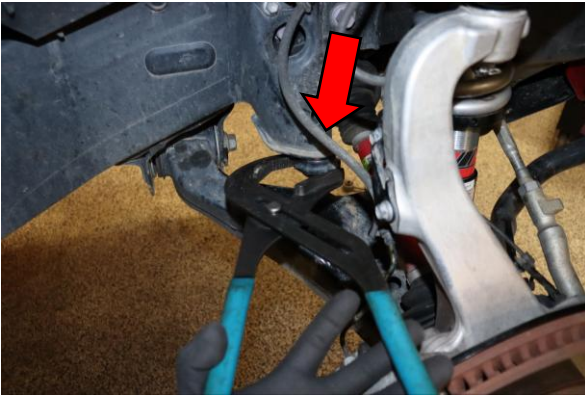

Step 30

Step 30. Remove the Front bump stop on each side.



Step 31

Step 31. Install the provided 6mm bump stop spacer to each side.



Step 32

Step 32. IF equipped with a skid plate reinstall

Step 33. Repeat steps 1-31 for other side. Double check to make sure everything is properly positioned and tightened, then, road test the vehicle and retighten if necessary.

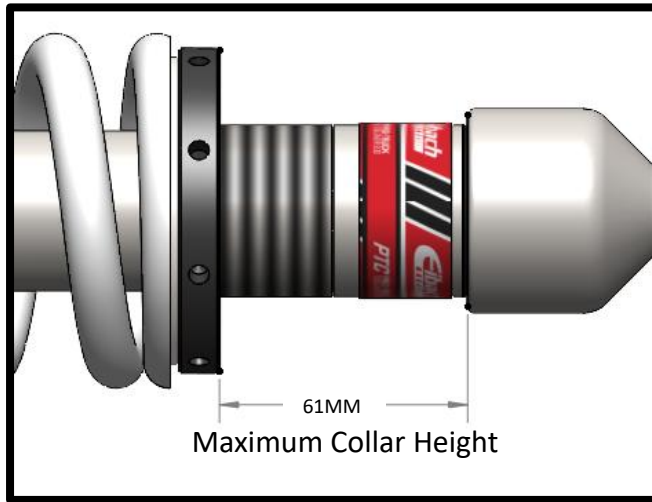

Note: Do NOT go above a spring collar height of 61mm from bottom of collar to base, as shown or else damage to the shock and suspension will occur.

Each full turn of the collar will result in approximately 1/8" in change of your ride height.
